

RTC 5 click

2. Soldering the headers

Before using your click board™, make sure to solder 1x8 male headers to both left and right side of the board. Two 1x8 male headers are included with the board in the package.

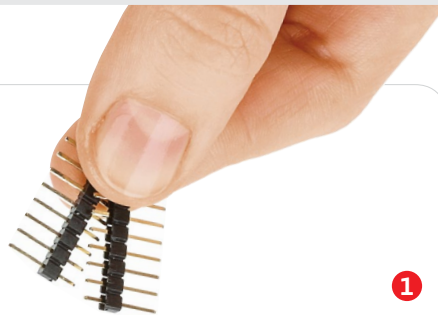

2

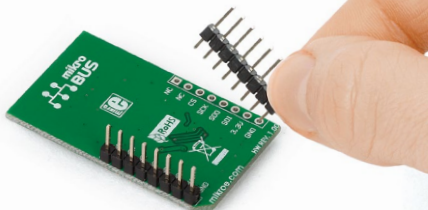

Turn the board upside down so that the bottom side is facing you upwards. Place shorter pins of the header into the appropriate soldering pads.

3

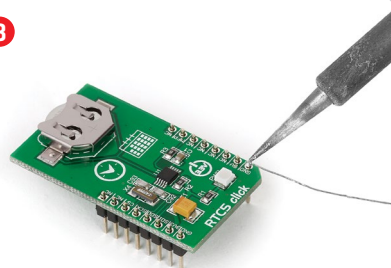

Turn the board upward again. Make sure to align the headers so that they are perpendicular to the board, then solder the pins carefully.

1. Introduction

RTC5 click carries **MCP79510**, a real-time clock/calendar with an SPI interface [mikroBUS™ MISO, MOSI, SCK and CS pins] and a programmable interrupt for system output. The clock frequency is derived from an onboard 32.768KHz oscillator. For backup power, RTC5 click has a coin-cell Lithium polymer battery connector. The board is designed to use a 3.3V power supply only.

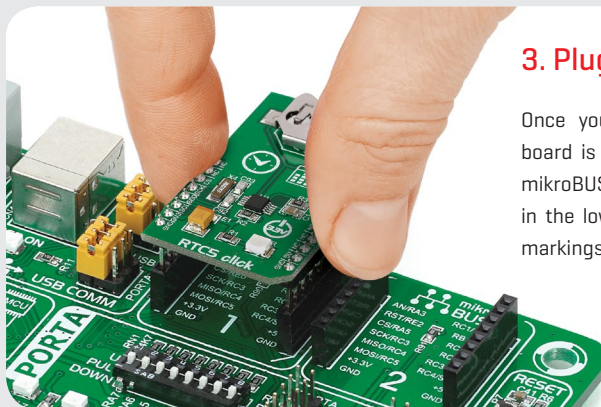

3. Plugging the board in

Once you have soldered the headers your board is ready to be placed into the desired mikroBUS™ socket. Make sure to align the cut in the lower-right part of the board with the markings on the silkscreen at the mikroBUS™ socket. If all the pins are aligned correctly, push the board all the way into the socket.

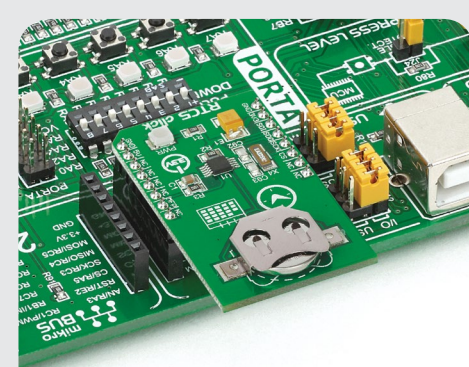

4. Essential features

For storing data, the chip onboard RTC5 click has **64-bytes of battery-backed SRAM and 1 kbit of EEPROM**, along with 128 bits of protected space for storing a unique ID. The SPI interface has clock speeds of up to 5 MHz which is enough for a millisecond alarm. The clock/calendar automatically compensates for leap years and months shorter than 31 days. The interrupt pin can be used to set up alarms or events.

click
BOARD™
www.mikroe.com



RTC 5 click Manual v100



0100000085769

5. Schematic

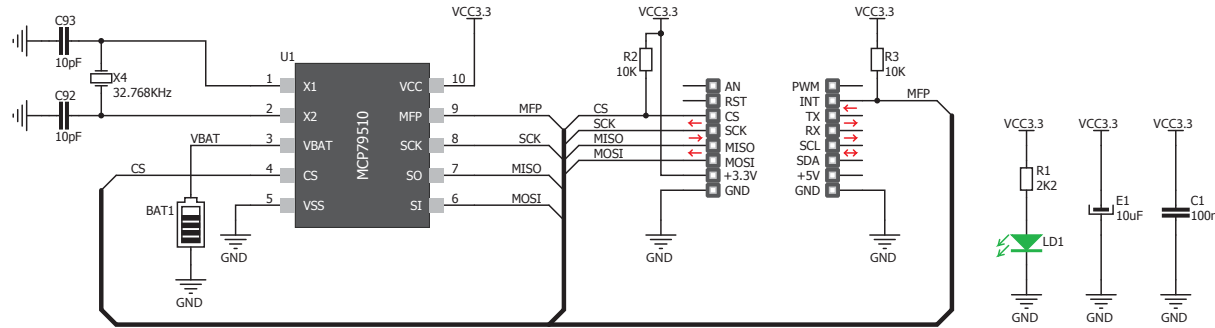

6. Dimensions

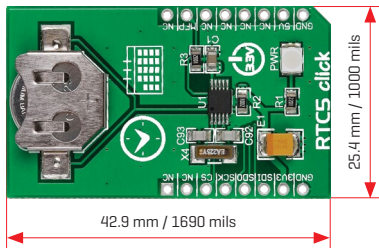

	mm	mils
LENGTH	42.9	1690
WIDTH	25.4	1000
HEIGHT*	3.9	154

* without headers

7. RTC5 click™ alternatives

RTC5 click, as the name implies, is the fifth click board™ with a real time clock module. Visit the click board™ page to see all available alternatives. Including RTC click which can also work on a 5V power supply.

www.mikroe.com/click

8. Code examples

Once you have done all the necessary preparations, it's time to get your click board™ up and running. We have provided examples for mikroC™, mikroBasic™ and mikroPascal™ compilers on our **Libstock** website. Just download them and you are ready to start.



9. Support

MikroElektronika offers **free tech support** [www.mikroe.com/support] until the end of the product's lifetime, so if something goes wrong, we're ready and willing to help!



10. Disclaimer

MikroElektronika assumes no responsibility or liability for any errors or inaccuracies that may appear in the present document. Specification and information contained in the present schematic are subject to change at any time without notice.

Copyright © 2015 MikroElektronika.
All rights reserved.

Mouser Electronics

Authorized Distributor

Click to View Pricing, Inventory, Delivery & Lifecycle Information:

[MikroElektronika:](#)

[MIKROE-1990](#)