

### PROTECTION PRODUCTS - RailClamp®

#### Description

RailClamp® TVS diodes are specifically designed to protect sensitive components which are connected to high-speed data and transmission lines from overvoltage caused by ESD (electrostatic discharge), CDE (cable discharge events), and EFT (electrical fast transients).

The RClamp2431TQ has a typical capacitance of only 0.35pF. This allows it to be used on Wi-Fi, RFID, and other circuits operating in excess of 3GHz without signal attenuation. It may be used to meet the ESD immunity requirements of IEC 61000-4-2.

The RClamp2431TQ is in a 2-pin SLP1006P2T package measuring 1.0 x 0.6 x 0.4mm. The leads are spaced at a pitch of 0.65mm and feature a lead-free finish. Each device will protect one high-speed line operating up to 24 volts. It gives the designer the flexibility to protect single lines in applications where arrays are not practical. The combination of small size, low capacitance, and high ESD surge capability makes it ideal for use in portable equipment such as cellular phones and netbooks.

The RClamp2431TQ is qualified to AEC-Q100 Grade1 for use in Automotive environments.

#### Features

- ◆ Transient protection for data lines to **IEC 61000-4-2 (ESD)**  
**IEC 61000-4-4 (EFT)**
- ◆ Ultra-small package (1.0 x 0.6 x 0.4mm)
- ◆ Protects one data line or one I/O pair
- ◆ Low capacitance: 0.35pF (Typical)
- ◆ Low clamping voltage
- ◆ 24V operating voltage
- ◆ Solid-state silicon-avalanche technology
- ◆ Qualified to AEC-Q100 Grade1 for Automotive

#### Mechanical Characteristics

- ◆ SLP1006P2T package
- ◆ Molding compound flammability rating: UL 94V-0
- ◆ Marking: Marking code
- ◆ Packaging : Tape and Reel
- ◆ Lead Finish: NiPdAu
- ◆ Pb-Free, Halogen Free, RoHS/WEEE Compliant

#### Applications

- ◆ Automobile Antenna
- ◆ CAN Bus Ports
- ◆ Cellular Handsets & Accessories
- ◆ Wi-Fi Interfaces
- ◆ FeliCa / RFID
- ◆ Firewire
- ◆ Serial ATA

#### Package Dimensions

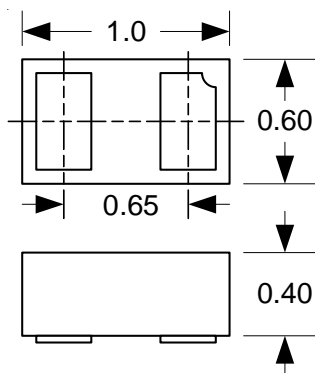

**Maximum Dimensions (mm)**

#### Schematic & Pin Configuration

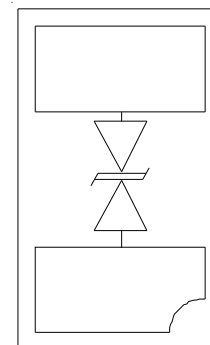

**SLP1006P2T (Bottom View)**

## PROTECTION PRODUCTS

### Absolute Maximum Ratings

| Rating   | Symbol    | Value           | Units |
|--|-----------|-----------------|-------|
| Peak Pulse Power (tp = 8/20μs)                                 | $P_{pk}$  | 100             | Watts |
| Peak Pulse Current (tp = 8/20μs)                               | $I_{pp}$  | 2               | A     |
| ESD per IEC 61000-4-2 (Air)<br>ESD per IEC 61000-4-2 (Contact) | $V_{ESD}$ | +/- 13<br>+/- 8 | kV    |
| Operating Temperature  | $T_J$     | -40 to +125     | °C    |
| Storage Temperature  | $T_{STG}$ | -55 to +150     | °C    |

### Electrical Characteristics (T=25°C unless otherwise specified)

| Parameter                 | Symbol    | Conditions                    | Minimum | Typical | Maximum | Units |
|---------------------------|-----------|-------------------------------|---------|---------|---------|-------|
| Reverse Stand-Off Voltage | $V_{RWM}$ |                               |         |         | 24      | V     |
| Reverse Breakdown Voltage | $V_{BR}$  | $I_t = 1mA$                   | 26.7    |         | 36      | V     |
| Reverse Leakage Current   | $I_R$     | $V_{RWM} = 24V$               | T=25°C  | 5       | 50      | nA    |
|                           |           |                               | T=125°C |         | 500     |       |
| Clamping Voltage          | $V_C$     | $I_{pp} = 1A, tp = 8/20\mu s$ |         |         | 45      | V     |
| Clamping Voltage          | $V_C$     | $I_{pp} = 2A, tp = 8/20\mu s$ |         |         | 50      | V     |
| Junction Capacitance      | $C_J$     | $V_R = 0V, f = 1MHz$          | T=25°C  | 0.35    | 0.5     | pF    |
|                           |           |                               | T=125°C |         | 1.0     |       |

## PROTECTION PRODUCTS

### Typical Characteristics

#### Non-Repetitive Peak Pulse Power vs. Pulse Time

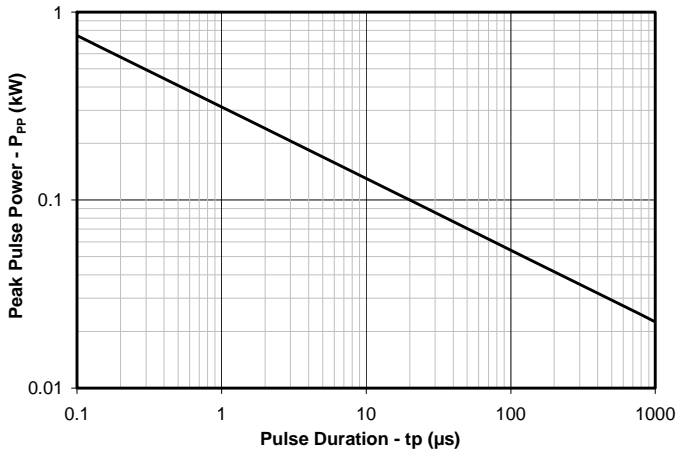

#### Power Derating Curve

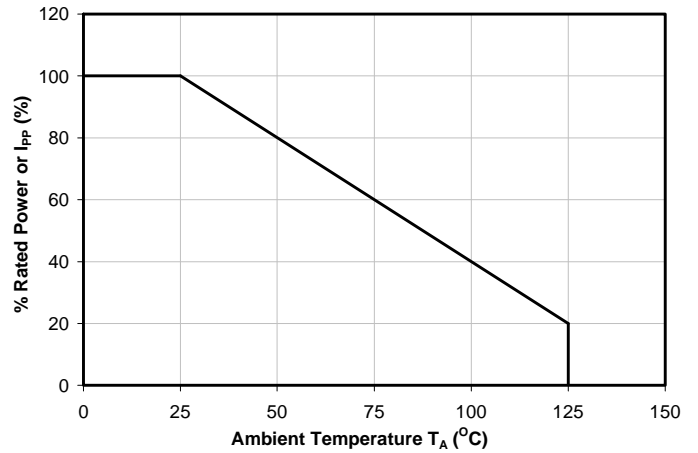

#### Typical Clamping Voltage vs. Peak Pulse Current

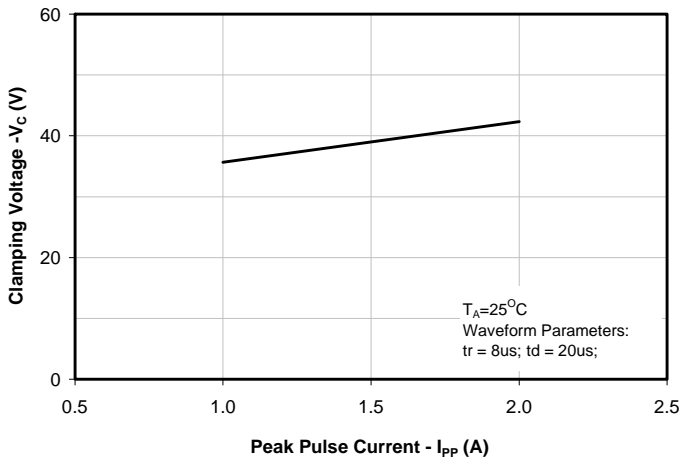

#### Typical Capacitance vs. Reverse Voltage

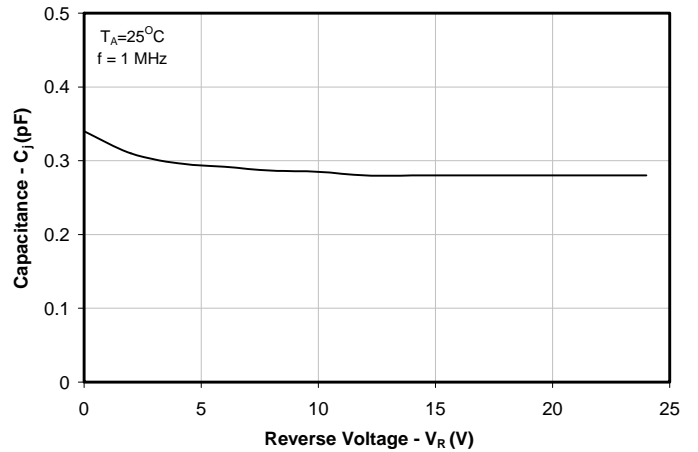

#### ESD Clamping (8kV Contact per IEC 61000-4-2)

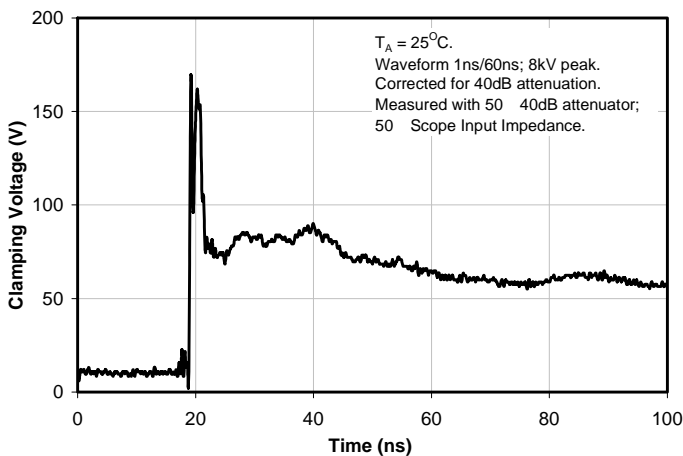

#### Insertion Loss S21

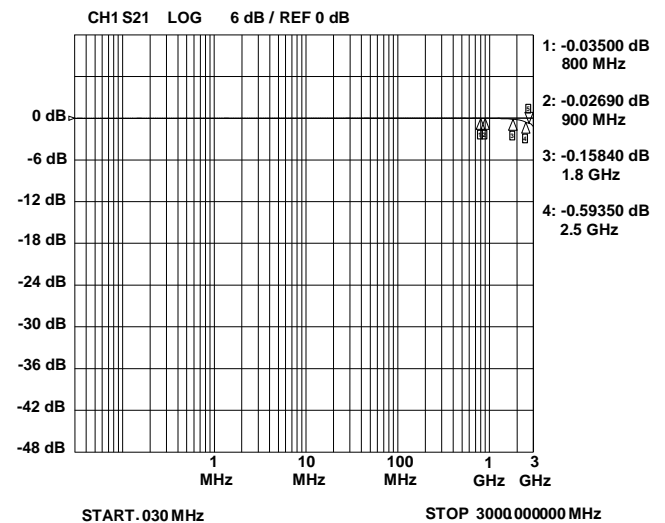

## PROTECTION PRODUCTS

### Typical Characteristics

**Typical Junction Capacitance v Temperature**

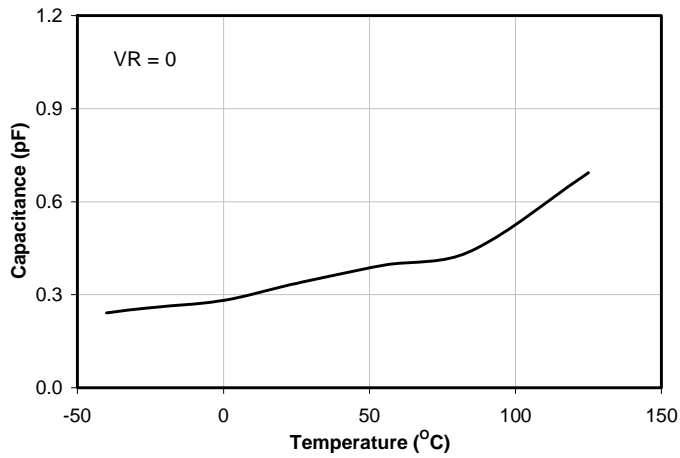

**Typical Reverse Leakage Current v Temperature**

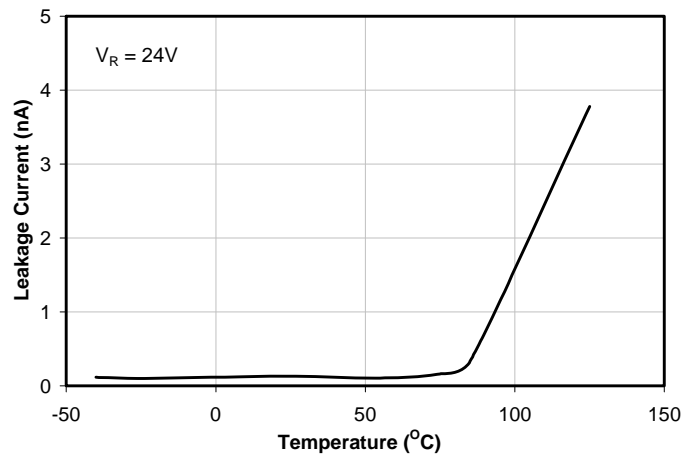

**Typical Breakdown Voltage v Temperature**

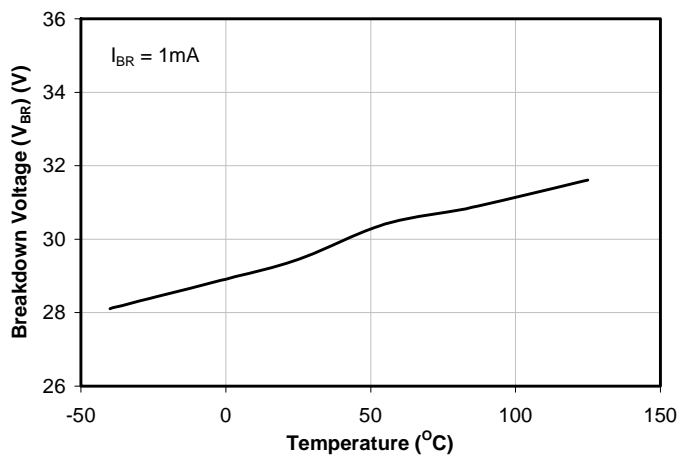

**PROTECTION PRODUCTS****Applications Information****Device Connection Options**

These low capacitance TVS diodes are designed to provide common mode protection for one high-speed line or differential protection for one line pair. The device is bidirectional and may be used on lines where the signal polarity is positive and negative.

**Circuit Board Layout Recommendations for Suppression of ESD.**

Good circuit board layout is critical for the suppression of ESD induced transients. The following guidelines are recommended:

- Place the TVS near the input terminals or connectors to restrict transient coupling.
- Minimize the path length between the TVS and the protected line.
- Minimize all conductive loops including power and ground loops.
- The ESD transient return path to ground should be kept as short as possible.
- Never run critical signals near board edges.
- Use ground planes whenever possible.

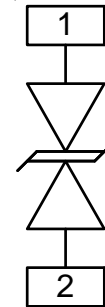
**Equivalent Circuit Diagram**

PROTECTION PRODUCTS

Outline Drawing - SLP1006P2T

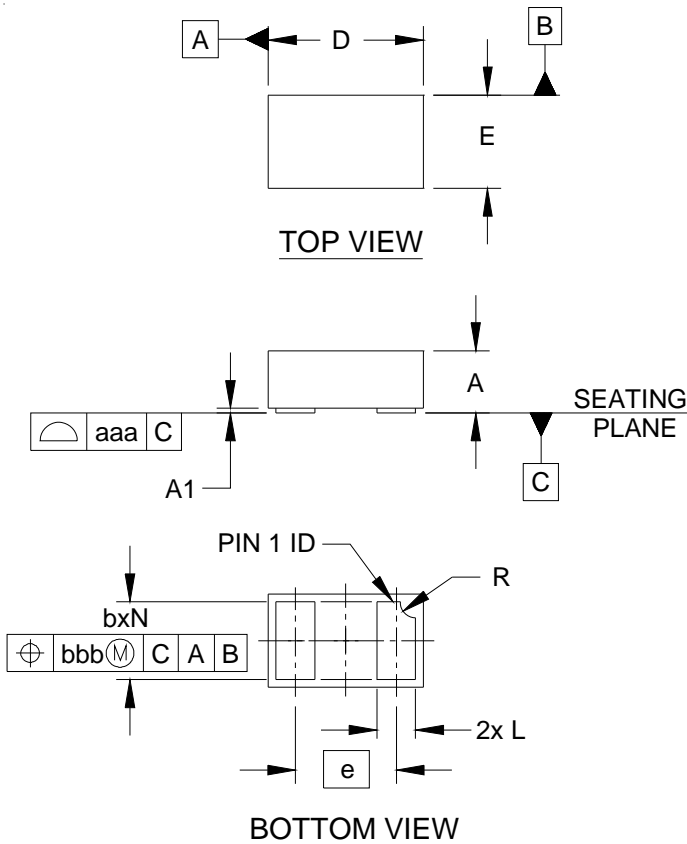

| DIM | INCHES   |      |      | MILLIMETERS |      |      |
|-----|----------|------|------|-------------|------|------|
|     | MIN      | NOM  | MAX  | MIN         | NOM  | MAX  |
| A   | .015     | .016 | .017 | 0.37        | 0.40 | 0.43 |
| A1  | .000     | .001 | .002 | 0.00        | 0.03 | 0.05 |
| b   | .018     | .020 | .022 | 0.45        | 0.50 | 0.55 |
| D   | .035     | .039 | .043 | 0.90        | 1.00 | 1.10 |
| E   | .020     | .024 | .028 | 0.50        | 0.60 | 0.70 |
| e   | .026 BSC |      |      | 0.65 BSC    |      |      |
| L   | .008     | .010 | .012 | 0.20        | 0.25 | 0.30 |
| R   | .002     | .004 | .006 | 0.05        | 0.10 | 0.15 |
| N   | 2        |      |      | 2           |      |      |
| aaa | .003     |      |      | 0.08        |      |      |
| bbb | .004     |      |      | 0.10        |      |      |

NOTES:

1. CONTROLLING DIMENSIONS ARE IN MILLIMETERS (ANGLES IN DEGREES).

Land Pattern - SLP1006P2T

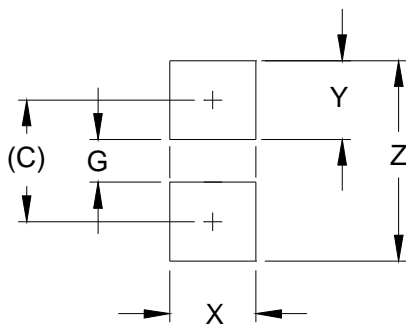

| DIM | DIMENSIONS |             |
|-----|------------|-------------|
|     | INCHES     | MILLIMETERS |
| C   | (.033)     | (0.85)      |
| G   | .012       | 0.30        |
| X   | .024       | 0.60        |
| Y   | .022       | 0.55        |
| Z   | .055       | 1.40        |

NOTES:

1. CONTROLLING DIMENSIONS ARE IN MILLIMETERS (ANGLES IN DEGREES).
2. THIS LAND PATTERN IS FOR REFERENCE PURPOSES ONLY.  
CONSULT YOUR MANUFACTURING GROUP TO ENSURE YOUR COMPANY'S MANUFACTURING GUIDELINES ARE MET.

## PROTECTION PRODUCTS

### Marking

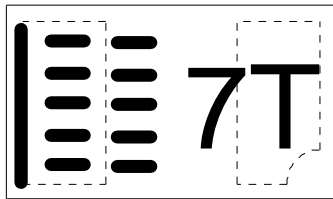

### Ordering Information

| Part Number      | Working Voltage | Qty per Reel | Reel Size |
|------------------|-----------------|--------------|-----------|
| RClamp2431TQ.TCT | 24V             | 3,000        | 7 Inch    |

Note: Lead finish is lead-free NiPdAu.

RailClamp and RClamp are marks of Semtech Corporation.

#### Notes:

- 1) Marking will also include line matrix date code
- 2) Device is electrically symmetrical

### Tape and Reel Specification

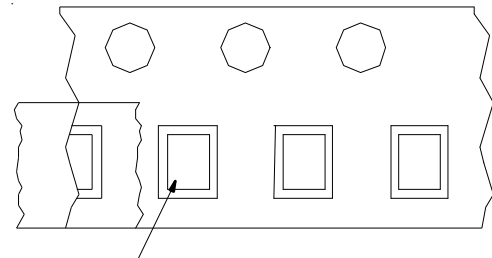
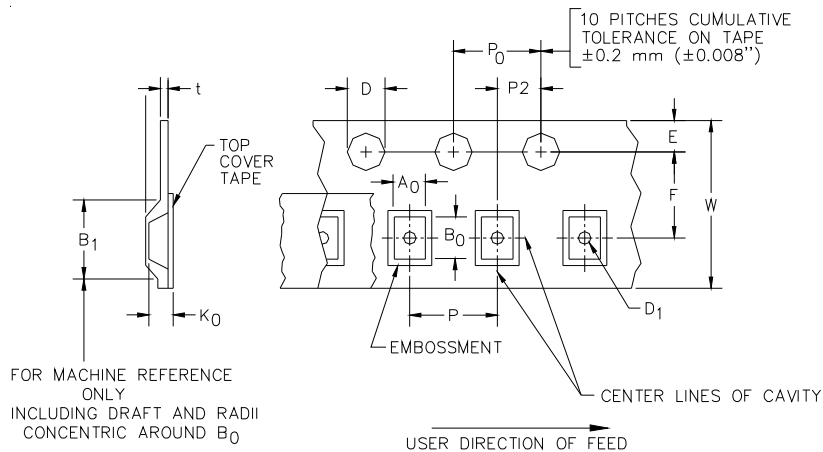

Cathode Bar Location

→ User Direction of feed

#### Device Orientation in Tape

| A0              | B0              | K0              |
|-----------------|-----------------|-----------------|
| 0.69 +/-0.10 mm | 1.19 +/-0.10 mm | 0.66 +/-0.10 mm |

| Tape Width | B, (Max)      | D   | D1                  | E                        | F                       | K (Max)       | P                       | P0                     | P2                      | T (Max)      | W                                    |
|------------|---------------|---|---------------------|--------------------------|-------------------------|---------------|-------------------------|------------------------|-------------------------|--------------|--------------------------------------|
| 8 mm       | 4.2 mm (.165) | 1.5 + 0.1 mm - 0.0 mm (0.59 +.005 - .000) | 0.8 mm ±0.25 (.031) | 1.750±0.1 mm (.069±.004) | 3.5±0.05 mm (.138±.002) | 2.4 mm (.094) | 4.0±0.10 mm (.157±.004) | 4.0±0.1 mm (.157±.004) | 2.0±0.05 mm (.079±.002) | 0.4mm (.016) | 8.0 mm + 0.3 mm - 0.1 mm (.312±.012) |

### Contact Information

Semtech Corporation  
 Protection Products Division  
 200 Flynn Rd., Camarillo, CA 93012  
 Phone: (805)498-2111 FAX (805)498-3804

# Mouser Electronics

Authorized Distributor

Click to View Pricing, Inventory, Delivery & Lifecycle Information:

[Semtech:](#)

[RCLAMP2431TQTCT](#)